











-  silver
-  white
-  black
-  SS



Dublin Tilt & Turn
with powder coated, brushed or sandblasted finish



-  silver
-  white
-  black
-  SS



Dublin Tilt & Turn Lockable
with powder coated, brushed or sandblasted finish



-  alu
-  bronze
-  SS



FSB 1004 Tilt & Turn
special order, various finishes available



-  fine matt
-  SS





Eureka Tilt & Turn
with concealed fixing



-  fine matt
-  SS

Eureka Tilt & Turn Lockable
with concealed fixing



-  silver
-  white
-  black/brown
-  cream



Si-Line Tilt & Turn
with coated or anodised finish



-  silver
-  white



Si-Line Tilt & Turn Lockable
with coated or anodised finish



-  silver
-  white
-  black

Toulon Tilt & Turn
with concealed fixing



-  silver
-  white
-  black

Toulon Tilt & Turn Lockable
with concealed fixing



-  silver
-  white
-  brown
-  black

Victory Tilt & Turn
with coated finish



-  silver
-  white
-  brown
-  black

Victory Tilt & Turn Lockable
with coated finish



silver
 white
 steel

Ascot Lift & Slide Flush Pull
long & short available

fine matt

Ascot Lift & Slide Oval Flush Pull
with invisible fixing

fine matt

Ascot Lift & Slide Square Flush Pull
with invisible fixing

silver
 white
 black
 cream

Concealed Sliding
with coated or anodised finish

silver
 white
 black/brown
 black

Portal Flush Pull
with coated or anodised finish

bronze
 SS

FSB 1004 Lift & Slide
special order, various finishes available

fine matt

Eureka HSG 1010 Lift & Slide
with invisible fixing

silver
 white
 steel

Ascot HSG 1040 Lift & Slide
with invisible fixing

silver
 white
 black

Toulon Lift & Slide
with coated or anodised finish

silver
 white

Si-Line Internal Lift & Slide without PZ
with coated or anodised finish

silver
 white
 black/brown

Si-Line Lift & Slide without PZ
with coated or anodised finish

silver
 white
 black/brown
 black

Si-Line Lift & Slide with PZ
with coated or anodised finish

silver
 white
 black/brown
 black

Si-Line External Lift & Slide with PZ
with coated or anodised finish

silver
 white
 black/brown
 black

Si-Line Internal Lift & Slide with PZ
with coated or anodised finish

silver
 white

Ascot FGS 1758 Balcony
with coated or anodised finish



silver
 white

Ascot FGS 1758 Flat Balcony
with coated or anodised finish



silver
 white
 brown
 black

Victory Balcony
with coated finish



silver
 white
 black/
brown





Si-Line PSK Balcony Set
with coated or anodised finish



silver
 white





Si-Line Balcony Set
with coated or anodised finish

-  satin chrome
-  satin black
-  satin brass
-  polished chrome





Bella (BL)
with through bolt fixing, fully concealed



-  satin chrome
-  satin black
-  satin brass
-  polished chrome





Catalina (CA)
with through bolt fixing, fully concealed



-  satin chrome
-  satin black
-  satin brass
-  polished chrome

Club (CL)
with through bolt fixing, fully concealed



-  satin chrome
-  satin black
-  satin brass
-  polished chrome





Daniela (DA)
with through bolt fixing, fully concealed



-  fine matt





Eureka (EU)
with through bolt fixing, fully concealed



-  satin chrome
-  satin black
-  satin brass
-  polished chrome





Gabriella (GA)
with through bolt fixing, fully concealed



-  satin chrome
-  satin black
-  satin brass
-  polished chrome





Guiletta (GI)
with through bolt fixing, fully concealed



-  satin chrome
-  satin black
-  satin brass
-  polished chrome

Lanex (LX)
with through bolt fixing, fully concealed



-  satin chrome
-  satin black
-  satin brass
-  polished chrome



Lanex - Timber (TLX)
with through bolt fixing, fully concealed



-  satin chrome
-  satin black
-  satin brass
-  polished chrome





Montana (MT)
with through bolt fixing, fully concealed



-  satin chrome
-  polished chrome



Prisma (PR)
with through bolt fixing, fully concealed



-  satin chrome
-  satin black
-  satin brass
-  polished chrome

Zola (ZO)
with through bolt fixing, fully concealed



-  alu
-  bronze
-  SS

FSB 1004 with Escutcheon
special order, various finishes available



-  fine matt



Backing plate PR83
with through bolt fixing, fully concealed



-  fine matt



Backing plate PS103L-E
with through bolt fixing, fully concealed

-  silver
-  white
-  fine matt



Ascot DGT50 Entrance
with coated, anodised or stainless steel finish



-  silver
-  black
-  SS

Berlin 50 Entrance
with brushed anodised finish



-  silver
-  black
-  SS



Dublin 35 Entrance
with brushed anodised finish



-  silver
-  black
-  SS



Dublin 50 Entrance
with brushed anodised finish



-  alu
-  bronze
-  SS



FSB 1004 Entrance
special order, various finishes available



-  silver
-  white
-  black





Si-Line Entrance
with coated or anodised finish



-  silver
-  white
-  black

Toulon Entrance
with coated or anodised finish



-  silver
-  white
-  brown
-  black

Victory Entrance
with coated finish



-  fine matt



Ascot External Round Escutcheon
with invisible fixing



-  fine matt



Ascot Internal Oval Escutcheon
with invisible fixing



-  silver
-  black
-  SS



Oslo 50 Rosette
with brushed finish



-  silver
-  black
-  INOX

Riga Rosette
with brushed anodised finish



-  silver
-  black
-  INOX

Sofia Rosette
with brushed anodised finish

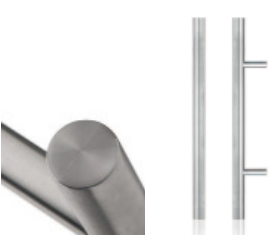
fine matt
Lengths (mm):
400, 800,
1200, 1600

Ascot Round Pull Bar
with 90° support

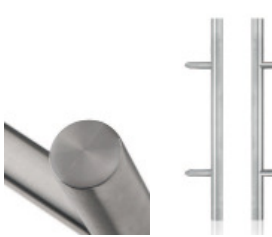

fine matt
Lengths (mm):
400, 800,
1200, 1600

Ascot Round Pull Bar
with 45° support

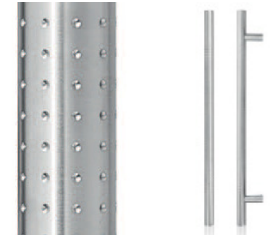

fine matt
Lengths (mm):
600, 1000,
1400

Ascot Round Pull Bar with Mill Dots
with 90° support

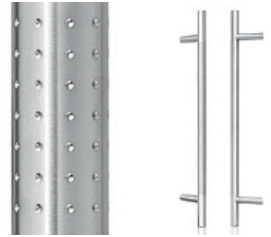

fine matt
Lengths (mm):
600, 1000,
1400

Ascot Round Pull Bar with Mill Dots
with 45° support



fine matt
Lengths (mm):
600, 1000

Ascot Flat Pull Bar
with 90° support



fine matt
Length (mm):
840

Ascot Curved Flat Pull Bar
with 90° support



silver
black
SS
Lengths (mm):
500, 800, 1000

Paris Round Pull Bar
with 90° support & brushed finish



silver
black
SS
Lengths (mm):
500, 800, 1000

Paris Round Pull Bar
with 45° support & brushed finish



silver
black
SS
Lengths (mm):
500, 800, 1000

Lisbon Flat Pull Bar
with 90° support & brushed finish



silver
black
SS
Lengths (mm):
500, 800, 1000

Lisbon Flat Pull Bar
with 45° support & brushed finish



fine matt
Lengths:
800mm

Ascot Round Pull Bar with Birch Inlay
with 45° support